



Geotechnical Investigation
Proposed 10th Avenue Estates
Residential Development

Owen Sound, Ontario

Submitted to:

Graham Construction & Design.
1260 2nd Avenue, Unit 2,
Owen Sound, Ontario
N4K 2J3

Submitted by:

GEI Consultants Ltd.
647 Welham Road, Unit 14
Barrie, Ontario, L4N 0B7
www.canada.geiconsultants.com

February 23, 2024
Project No. 2305091

Table of Contents

1.	Introduction	1
2.	Procedures and Methodology	2
3.	Subsurface Conditions	4
3.1	General Overview	4
3.2	Stratigraphy	4
3.3	Groundwater	6
4.	Engineering Design Parameters & Analysis	7
4.1	Site Grading	7
4.2	Foundation Design	8
4.3	Floor Slabs	11
4.4	Drainage	11
4.5	Site Servicing	11
4.6	Pavement Design	13
4.7	Stormwater Management Pond	15
5.	Constructability Considerations	17
5.1	Excavations	17
5.2	Temporary Construction Groundwater Control	18
5.3	Quality Verification Services	19
5.4	Site Work	20
6.	Limitations and Conclusions	21
6.1	Limitations	21
6.2	Conclusion	22

Figures

1. Site Location Plan
2. Borehole Location Plans
 - A. Aerial Image
 - B. Proposed Site Plan

Appendices

- A. Borehole Logs
- B. Geotechnical Laboratory Data
- C. Typical Details



1. Introduction

GEI Consultants Ltd. (GEI) was retained by Graham Construction & Design (the Client) to complete a geotechnical investigation and report for a proposed residential development at 10th Avenue East in Owen Sound, Ontario. A site location plan is enclosed as Figure 1.

Extension of an existing residential area east of 10th Avenue East, in the north part of Owen Sound, is proposed. At the east end of 23rd Street A East and 10th Avenue East there is an existing cul-de-sac. The road is to be extended easterly beyond the cul-de-sac to allow for the construction of more than 40 new homes. The homes are proposed to be slab-on-grade considering the wet conditions shown in the preliminary test pits conducted by others. The Kenny Drain is along the east edge of the property and is about 3 to 4 m below the grade of the site. Municipal servicing is to be extended to service the homes. A looping road will provide paved access to the new area. An aerial image of the site is provided on Figure 2A, and the proposed concept plan is included as Figure 2B.

The purpose of the geotechnical investigation was to assess the subsurface soil conditions at the site, and based on this information, provide geotechnical engineering recommendations in support of the proposed development. This report summarizes the borehole findings, provides geotechnical engineering recommendations regarding available bearing capacities for foundations, slabs-on-grade, site servicing installation, SWM pond and pavement design. Considerations for constructability such as soil excavation, compaction, on-site backfill suitability and temporary groundwater control are also provided.

It is noted that the recommendations provided in this report must be considered preliminary in nature due to the current uncertainty of the design for the project. As the design progresses further geotechnical review and input may be required which might necessitate the need for additional investigation and/or analysis.

Chemical testing or other environmental work are currently not part of the scope and are not addressed in this report.



2. Procedures and Methodology

It is noted that all elevations in this report are metric/geodetic and expressed in metres (m). All measurements are also in metric and expressed in millimetres (mm), metres (m) or kilometers (km).

Prior to the commencement of drilling activities, the borehole locations were staked in the field by GEI. Ground surface elevations of the boreholes and horizontal co-ordinates (referencing NAD 83 geodetic datum) were surveyed by GEI.

Underground utilities including natural gas, electrical, telephone, water, etc. were marked out by public and private utility locating companies.

The fieldwork for the drilling program was carried out on November 20, 2023. Boreholes 1 to 6 were advanced to 3.5 to 7.7 m below existing grade (Elev. 203.6 to 209.2). Borehole logs are provided in Appendix A and the borehole locations are shown on Figure 2A (aerial image) and Figure 2B (proposed plan).

The boreholes were advanced by a drilling subcontractor retained and supervised by GEI using a track-mounted drill rig, hollow stem augers, and standard soil sampling equipment. Sampling was conducted using a 51 mm O.D. Split Spoon (SS) sampler. Standard Penetration Test (SPT) “N” Values (N values) were recorded for the sampled intervals as the number of blows required to drive an SS sampler 305 mm into the soil using a 63.5 kg drop hammer falling 750 mm, in accordance with ASTM D1586. In each borehole soil sampling was conducted at 0.75 m intervals for the upper 3.0 m and at 1.5 m intervals thereafter.

Monitoring wells were installed in Boreholes 1, 2, 5 and 6 by GEI to facilitate long-term groundwater monitoring, each consisting of 50 mm diameter PVC pipe with a 1.5 m or 3.0 m long screen and protective casing. Monitoring well construction is shown on the borehole logs in Appendix A. Boreholes without wells were backfilled in accordance with O.Reg. 903.

The GEI field staff examined, and classified characteristics of the soils encountered in the boreholes, including the presence of fill materials (if any), groundwater observations during and upon completion of the drilling, recorded observations of borehole construction, and processed the recovered samples. All recovered soil samples were logged in the field, carefully packaged, and transported to GEI’s laboratory for more detailed examination and classification.



In GEI's laboratory, the samples were classified as to their visual and textural characteristics. Four (4) representative soil samples of the major soil units from the borehole, were selected and submitted to our laboratory for grain size analysis. Grain size results are provided in Appendix B.



3. Subsurface Conditions

3.1 General Overview

The detailed soil profiles encountered in the boreholes are indicated on the attached borehole logs in Appendix A, and the geotechnical laboratory results are included in Appendix B. The borehole locations are shown on Figures 2A and 2B.

It should be noted that the conditions indicated on the borehole logs are for specific locations only and can vary between and beyond the locations. It should be noted that the soil boundaries indicated on the borehole logs are inferred from non-continuous sampling and observations during drilling. These boundaries are intended to reflect approximate transition zones and should not be interpreted as exact planes of geological change.

In addition, the descriptions provided in the borehole logs are inferred from a variety of factors, including: visual observations of the soil samples retrieved, laboratory testing, measurements prior to and after drilling, and the drilling process itself (speed of drilling, shaking/grinding of the augers, etc.). The passage of time also may result in changes in conditions interpreted to exist at locations where sampling was conducted.

3.2 Stratigraphy

3.2.1 Topsoil

A surficial topsoil layer was at the ground surface in each borehole ranging in thickness between 75 to 200 mm. Topsoil thickness may vary between boreholes and in other areas of the site.

3.2.2 Fill

A discontinuous fill layer was observed below the topsoil in Borehole 5 to depth of 0.8 m (Elev. 213.9). The fill consisted of silty sand and gravel. The fill soil was moist with a moisture content of 16%. The soil had an N value of 17 (compact).

3.2.3 Clayey Silt

A layer of clayey silt was observed below the topsoil in Boreholes 1, 2, 4 and 6. The layer extended to depths ranging from 0.8 to 1.1 m depth (Elev. 207.4 to 209.1). One (1) sample of the material was submitted to our laboratory for grain size analysis and the results are provided in Figure B1 in Appendix B. The material was moist to very moist with moisture contents of 20 to 27%. The soil was firm to stiff, locally soft, with N values ranging from 3 to 9.



3.2.4 Layered Clayey Silt and Sandy Silt

Below the clayey silt in Boreholes 1, 2 and 6, a layered deposit of clayey silt and sandy silt was observed, which extended to 2.3 m depth (Elev. 205.9 to 207.6). The layered deposit had N values of 4 to 30 ranging from loose to compact/firm to very stiff. Moisture contents were 15 to 32 % and the soil was moist to very moist.

3.2.5 Sandy Silt

A layer of sandy silt was encountered below the topsoil fill and clayey silt in Boreholes 3, 4 and 5 and extended to 1.5 to 4.6 m below ground surface (Elev. 207.9 to 211.6). The soil was compact to dense, locally very dense, with N values ranging from 13 to 57. Moisture contents ranged from 5 to 16% and the soil was moist to wet.

3.2.6 Silt

A discontinuous layer of silt was encountered in Borehole 1 (2.3 to 3.0 m depth (Elev. 206.8 to 207.6)) and Borehole 4 (1.5 to 2.3 m depth (Elev. 207.1 to 207.9)) 207.1). This layer contained trace to some clay and sand. Two (2) samples of the material were submitted for grain size analysis and the results are provided in Figure B2 in Appendix B. The soil was wet with moisture contents of 18 and 23%. SPT N values of 6 and 9 were measured in this layer indicating a loose condition.

3.2.7 Gravelly Silty Sand

A local layer of gravelly silty sand was revealed in Borehole 3, below the sandy silt from 2.3 m depth to 3.0 m depth (Elev. 210.8 to 211.6). One (1) sample of the material was submitted for grain size analysis and the results are provided in Figure B3 in Appendix B. The soil was dense with an N value of 31. The material was wet, and the moisture content was 8%.

3.2.8 Silty Clay

Silty clay was observed in Boreholes 1, 4, 5 and 6, below the upper soil layers at depths ranging from 2.3 to 4.6 (Elev. 206.8 to 210.1) and extended to 3.1 to 6.1 m depth (Elev. 205.3 to 208.6). The soil was very soft to soft in Boreholes 1, 4 and 6 with N values of 4 or less. Locally the soil was very stiff in Borehole 5 with an N value of 26. Moisture contents were 13 to 36%.

3.2.9 Weathered Shale

Weathered shale bedrock was underlying the upper soil units in all boreholes. The shale bedrock surface was found/inferred at 2.3 m to 6.1 m depth (Elev. 205.3 to 210.8) and extended to the 3.5 to 7.7 m depth of exploration (Elev. 203.6 to 209.2). The shale appears to be highly weathered to the depth of the exploration yet showed blow counts of 50 or greater where



samples were taken. The augers locally refused in the shale. Moisture contents were taken were 5 to 12%.

3.3 Groundwater

Unstabilized groundwater level measurements and cave measurements were taken upon the completion of drilling of each borehole as shown on the borehole logs in Appendix A. These measurements were taken to provide a rough estimate of the possible excavation and temporary groundwater control constructability considerations that may arise. Four (4) boreholes were outfitted with a monitoring well with 50 mm diameter PVC standpipe and a 1.5 m or 3.0 m long screen. Monitoring well configuration and groundwater observations are noted on the borehole logs in Appendix A and summarized in the table below.

Borehole	Depth of Cave (m) / Elev.	Unstabilized Groundwater Level Depth (m) / Elev.	Depth (m) / Elev. of Groundwater Table, December 4, 2023
1	Open (4.7 / 205.2)	No Water	0.2 / 209.7
2	Open (4.6 / 203.6)	No Water	1.2 / 207.0
3	2.5 / 211.4	No Water	N/A
4	2.3 / 207.1	No Water	N/A
5	Open (7.7 / 207.0)	No Water	3.6 / 211.1
6	2.7 / 206.6	No Water	0.2 / 209.1

The stabilized groundwater levels in the monitoring wells in December 2023 were 0.2 to 3.6 m below the existing ground surface and ranged between Elev. 209.1 to 211.1.

The sandy silt, silt and silty gravelly sand are semi-permeable and expected to generally allow for some the free flow of water when wet. Clayey silt, silty clay and shale bedrock are generally not permeable.

Groundwater levels are expected to show seasonal fluctuations and vary in response to prevailing climate conditions.



4. Engineering Design Parameters & Analysis

Extension of an existing residential area east of 10th Avenue East, in the north part of Owen Sound, is proposed. At the east end of 23rd Street A East and 10th Avenue East there is an existing cul-de-sac. The road is to be extended easterly beyond the cul-de-sac to allow for the construction of more than 40 new homes. The homes are proposed to be slab-on-grade considering the wet conditions shown in the preliminary test pits conducted by others. The Kenny Drain is along the east edge of the property and is about 3 to 4 m below the grade of the site. Municipal servicing is to be extended to service the homes. A looping road will provide paved access to the new area. An aerial image of the site is provided on Figure 2A, and the proposed concept plan is included as Figure 2B.

It is noted that the recommendations provided in this report must be considered preliminary in nature due to the current uncertainty of the design for the project. As the design progresses further geotechnical review and input may be required which might necessitate the need for additional investigation and/or analysis.

4.1 Site Grading

Grading plans were not available for review at the time of this report, however it is speculated that some grading will be required for the site.

Of concern is the very soft to soft silty clay at depth in Boreholes 1, 4 and 6, and the accompanying potential for settlement if grades in these areas are raised more than about 1 m.

The above noted settlement concern will have to compete with the wet conditions and high groundwater table at the site that would promote a grade raise to help keep buildings out of the wet conditions.

Based on the competing conditions, it is suggested that the site be pre-loaded. Grades can be raised to keep the houses out of the wet conditions, but the grade raise for the site should occur in the sensitive areas at least six months to a year in advance of any construction to allow any settlement to take place. These areas should be monitored once the fill is in place to see when the settlement slows/stops.

When grading is established, GEI should review the drawings for geotechnical requirements.

4.1.1 Engineered Fill

GEI defines “engineered fill” as material that will support foundations, and which is placed and compacted in a specified and controlled manner under full-time supervision of geotechnical engineering staff.



In any location where engineered fill will be placed to raise grades or replace poor/weak soil, the topsoil, vegetation, organics, local fill in Borehole 5 and the very soft to soft clayey silt in Boreholes 1 and 2 directly below the topsoil must be fully removed down to competent soil. The exposed subgrade soil must be proof-rolled and inspected by the geotechnical engineer to ensure all unsuitable material (e.g. organics, weak or soft soil, weathered / disturbed soil, deleterious materials, existing fill) is removed from the engineered fill footprint. Any unsuitable areas must be further sub-excavated and replaced with approved fill compacted to targeted 100% Standard Proctor maximum dry density (SPmdd), minimum 98% SPmdd in building areas and 95% SPmdd in road and servicing areas.

Once the subgrade is approved, engineered fill can be placed. Engineered fill must be placed under the full-time supervision of a geotechnical engineer as required in the Ontario Building Code. The engineered fill may consist of excavated on-site cohesionless soils provided they have been moisture conditioned to a moisture content within 2% of optimum moisture content and are unfrozen and free of organics, topsoil or deleterious material. It is recommended that any imported soil consist of Granular B (OPSS.MUNI 1010) and be first used in building areas, with suitable on-site soil used in landscaped or road areas. Engineered fill must be placed in loose lifts of 200 mm or less and compacted as noted above.

In wet subgrade areas, the first lift of engineered fill shall consist of 400 mm to 600 mm of Granular B Type II (OPSS.MUNI 1010). This will help to bridge the weaker subgrade and improve the ability to achieve the compaction specifications for subsequent engineered fill lifts.

The engineered fill must extend a minimum of 1 m out from all sides of the foundations and extend at a 1 horizontal to 1 vertical slope (1H:1V) down to the exposed subgrade. A typical detail for engineered fill pad dimensioning is included in Appendix C.

4.2 Foundation Design

4.2.1 Foundations on Native Soil

Grading was not established at the time of this report and therefore footing levels were not known. When grading is established, GEI should review the drawings for geotechnical requirements and to confirm bearing resistance values.

Foundations at the west of the tree line at Boreholes 3 and 5 may be constructed as conventional shallow spread and strip footing foundations that bear on the native, undisturbed soil at or below 1.0 m depth below existing grade and may be designed using a geotechnical bearing resistance at Serviceability Limit State (SLS) of 150 kPa and a factored bearing resistance at Ultimate Limit State (ULS) of 225 kPa.



Whereas, in Boreholes 1, 2, 4 and 6 east of the tree line, variable and typically loose soil in the upper 2 to 3 m, underlain by the very soft to soft silty clay would typically only provide a reduced geotechnical bearing resistance at SLS of 50 kPa and a factored bearing resistance at ULS of 75 kPa, possibly less depending on the depth of the proposed footings. The soil resistances will have to be reviewed once the locations and depth are designed. Alternatively, the weak soil can be removed and replaced with engineered fill as discussed in the next section.

Higher bearing resistances are available at depth in the shale bedrock and can be provided upon request.

Final footing elevations must be reviewed by geotechnical personnel from GEI to confirm bearing capacity values. The final site configuration must also be reviewed by GEI to assess the potential for footings to be founded on different soil subgrades, and to assess the potential for differential settlement. It is recommended that all foundations for each individual building / structure be set on the same soil subgrade wherever possible, to reduce the potential for differential settlement.

4.2.2 Foundations on Engineered Fill

If the foundations are supported on an engineered fill pad, constructed as discussed in Section 4.1.1, the spread or strip footings can be designed using the same geotechnical reaction at SLS and factored geotechnical resistance at ULS as the underlying native soil to a maximum of 150 kPa at SLS and 225 kPa at ULS. Where weak soil is below the engineered fill, and where the engineer fill is 1 m or thicker, slightly higher bearing resistance values are available for design of footings and can be reviewed when design details are established.

It is recommended that nominal reinforcing steel for stiffening of the foundation walls made on engineered fill be provided to help mitigate minor cracking due to minor differential settlement. The reinforcing steel in the poured concrete foundation walls may consist of 2-15M bars continuous at the top of the foundation wall, and 2-15M bars continuous at the bottom of the foundation walls. Typically, these bars are placed 100 to 200 mm from the top or bottom of the foundation wall, respectively. The reinforcing steel should extend a minimum of 3 m past any transition zones between engineered fill and native soil. A typical reinforcing steel detail for foundation walls placed on engineered fill is provided within Appendix C. The recommended nominal reinforcing steel should not be considered a structural design. The need for different or additional reinforcement should be reviewed by a structural engineer to ensure the original structural design intent of the structure is maintained.

4.2.3 General Foundation Considerations

All footings exposed to ambient air temperature throughout the year must be provided with a minimum of 1.5 m of earth cover or provided with equivalent insulation for frost protection (typically 25 mm of polystyrene insulation is equivalent to 300 mm of soil cover). The



minimum strip and spread footing widths to be used shall be dictated as per the Ontario Building Code, regardless of loading considerations. Footings stepped from one level to another must be at a slope not exceeding 7V:10H. The maximum horizontal step must not exceed 600 mm.

The foundation design parameters provided above are predicated on the assumption that the foundation subgrade surface is undisturbed, and that all deleterious, softened, disturbed, organic, and caved material is removed. The foundation excavation must be done in such a way that groundwater is controlled to prevent any disturbance to the foundation base. Temporary groundwater control may be required at some locations to facilitate the foundation construction as discussed in Section 5.2. The groundwater table must be lowered at least 1 m below the founding elevation prior to excavation to prevent disturbance to the foundation subgrade from groundwater seepage.

The foundation subgrade must be reviewed prior to concrete placement to ensure the foundation design parameters provided are applicable, and to provide remedial recommendations if necessary. If the foundation excavation will be open for a prolonged period of time, the foundation subgrade should be protected with a skim coat of lean mix concrete (applied immediately after inspection by the geotechnical engineer), to ensure that no deterioration will occur due to weather effects.

The footings must not be constructed on frozen ground. If footing construction extends into the winter, the bearing soil and fresh concrete should be protected from freezing during cold weather construction.

4.2.4 Seismic Site Class

Section 4.1.8.4 of the Ontario Building Code provides values of the acceleration and velocity-based site coefficients (F_a and F_v) for various time periods, associated with specific Site Classes. These Site Classes are based on the energy-corrected Average Standard Penetration Resistance values and undrained shear strength within the upper 30 m of soil underlying the grade beams or foundations of the proposed structure. As the boreholes were advanced less than this depth at the site, the site classification recommendation provided below assumes that the soil conditions are similar below the drilled depth.

Underneath the proposed foundations, the subsoil will consist of native soil and/or engineered fill over the weathered shale bedrock. Based on this, the Site Classification for Seismic Site Response is “D” for this site.



4.3 Floor Slabs

The native soils or engineered fill are suitable to support floor slabs. Topsoil, vegetation, organics, organics, in-situ earth fill and other soil containing organics, excessive moisture, or deleterious materials are not suitable to support floor slabs.

The exposed subgrade must be proof-rolled and inspected by the geotechnical engineer. If any soft or weak subgrade areas are identified, or if there are areas containing excessive amounts of deleterious/organic material, they must be locally sub-excavated and backfilled with approved clean earth fill or imported granular material placed in maximum 200 mm thick loose lifts and compacted to a minimum of 98% SPmdd within 2% optimum moisture content.

All building floor slabs must be provided with a capillary moisture barrier and drainage layer. This is made by placing the concrete slab on a minimum 200 mm layer of 19 mm clear stone (OPSS.MUNI 1004) compacted by vibration to a dense state. The upper 50 mm of clear stone can be replaced with 19 mm crusher run limestone for a working surface. The clear stone and subgrade must be separated by a geotextile such as Terrafix 270R (or approved equivalent) to prevent the migration of fines into the clear stone layer which could result in loss of support for the slab. Alternatively, Granular A (OPSS.MUNI.1010) compacted to 100% SPmdd, can be utilized without a geotextile.

4.4 Drainage

The proposed structure that will be slab-on-grade with no basement levels, perimeter and under-slab drainage at the foundation level is not required, provided that the underside of the concrete slab is at least 200 mm above the prevailing grade of the site and the surrounding surfaces slope away from the building at a gradient of at least 2% to promote surface water run-off and to reduce groundwater infiltration adjacent to foundations. To minimize infiltration of surface water, the upper 150 mm of backfill should comprise relatively impervious/cohesive compacted soil material.

4.5 Site Servicing

It is expected that the proposed residential development will be serviced with water, sanitary and storm sewers. Inverts were assumed to extend as deep as 3 m below existing grade for purposes of this report.

4.5.1 Bedding

The type of material and depth of granular bedding below the pipe will, to some extent, depend on the method of construction used by the contractor. Pipe bedding for flexible pipes should follow the requirements in Ontario Provincial Standard Drawing 802.010 or applicable



municipal standards. Pipe bedding for rigid pipes should follow the requirements in Ontario Provincial Standard Drawings 802.030 to 802.032 or applicable municipal standards.

A subgrade consisting of the undisturbed native soil at the site will provide adequate support for pipes with the bedding requirements as laid out in the above referenced OPS drawings. Where disturbance of the trench base has occurred from groundwater seepage, construction traffic, etc., or if in-situ fill is present at the invert level, the material should be sub-excavated and replaced with suitably compacted granular fill. If weak zones are encountered and potentially for a clay subgrade, additional bedding materials and differing construction practices may be required and should be determined during construction. Any zones of peat or organic soil should be sub excavated and replaced with approved earth fill or imported granular material compacted to 95% SPmdd. Details on temporary groundwater control are provided in Section 5.2.

Regardless of whether flexible or rigid pipes are implemented, granular bedding and cover material should consist of a well graded, free draining material, such as Granular A or B Type I (OPSS.MUNI 1010) compacted to a minimum of 98% SPmdd.

4.5.2 Backfill

Excavated inorganic native cohesionless soils may be re-used as backfill in trenches, provided they are moisture conditioned so that the moisture content is within 2% of optimum. Additional soil compaction details are provided in Section 5.3. The backfill should be placed in maximum 300 mm thick lifts and should be compacted to a minimum of 95% SPmdd. In confined areas the layer thickness will have to be reduced to utilize smaller compaction equipment efficiently or by using granular material instead of locally sourced fill. Any backfill that is frozen, contains a high percentage of organic material (topsoil, peat, etc.) or moisture, or has otherwise unsuitable deleterious inclusion should not be used as backfill. The maximum cobble or boulder size should not exceed half of the loose lift thickness (i.e., all particles with a diameter greater than 100 mm should be removed). The clayey soil will require a sheepsfoot compactor and may need to be dried out, which may be impractical.

Where trenches are within the traveled portions of a roadway, backfill within the frost penetration depth of 1.5 m should consist of native, non-organic, excavated material consistent with the soils surrounding the trench. If this technique is not undertaken, then frequently problems arise with yearly differential frost heave movements between the trench backfill and the adjacent native soil. This would occur, for example, if imported granular material is used to backfill trenches which is less susceptible to frost effects compared to the native soils on site with a higher silt content (silt is highly frost-susceptible). Alternatively, if different soil is used as the backfill due to issues with achieving compaction, a frost taper of 10H:1V can be implemented to help mitigate the potential for differential settlement and frost heave.



4.6 Pavement Design

The residential development will have a looping road, which will provide access to the townhomes, as shown on the conceptual plan Figure 2B.

4.6.1 Subgrade Preparation

The grading has not been completed at this time and the subgrade soil is uncertain but likely to comprise the soil in the upper 2.0 m of the boreholes. Based on this the pavement subgrade will comprise material with typically moderate to high frost susceptibility.

The subgrades must be inspected and approved by the geotechnical engineer at the time of construction. The exposed pavement subgrade should be compacted to a minimum 95% SPmdd. If any soft or weak subgrade areas are identified, or if there are areas containing excessive amounts of moisture or deleterious/organic material, they must be locally sub-excavated and backfilled with approved clean earth fill or imported granular material and compacted to a minimum of 95% SPmdd.

The long-term performance of the pavement structure is highly dependent upon the subgrade support conditions. Stringent construction control procedures must be maintained to ensure that uniform subgrade moisture and density conditions are achieved as much as possible when fill is placed, and the natural subgrade is not disturbed or weakened after it is exposed.

4.6.2 Drainage

Control of surface water is an important factor in achieving a good pavement life. The need for adequate subgrade drainage cannot be over-emphasized. The subgrade must be free of depressions and sloped (at a minimum grade of 2 percent) to provide effective drainage toward subgrade drains. Grading adjacent to pavement areas should be designed to ensure that water is not allowed to pond adjacent to the outside edges of the pavement.

Continuous pavement subdrains should be provided along both sides of the roadways and drained into respective catchbasins to facilitate drainage of the subgrade and the granular materials. The subdrain invert should be maintained at least 0.3 m below subgrade level. To minimize the problems of differential movement between the pavement and catchbasins/manhole due to frost action, the backfill around the structures should consist of free-draining OPSS Granular B. Typical pavement drainage details are provided in Appendix C.



4.6.3 Pavement Structure

The following pavement thickness design is provided on a preliminary basis and should be confirmed when the pavement subgrade soil is known:

Pavement Layer	Compaction Requirements	Residential Road
<u>Surface Course Asphaltic Concrete:</u> HL-3 (OPSS.MUNI 1150) with PG 58-28 Asphalt Cement (OPSS.MUNI 1101)	OPSS.MUNI 310	40 mm
<u>Binder Course Asphaltic Concrete:</u> HL-4 (OPSS.MUNI 1150) with PG 58-28 Asphalt Cement (OPSS.MUNI 1101)	OPSS.MUNI 310	50 mm
<u>Base Course:</u> Granular A (OPSS.MUNI 1010)	100% SPmdd (ASTM-D698)	150 mm
<u>Subbase Course:</u> Granular B Type I (OPSS.MUNI 1010)	100% SPmdd (ASTM- D698)	500 mm

The granular materials should be placed in lifts 200 mm thick or less and be compacted to a minimum of 100% SPmdd for both granular base and subbase. Asphalt materials should be rolled and compacted as per OPSS.MUNI 310. The granular and asphalt pavement materials and their placement should conform to OPSS.MUNI 310, 501, 1010 and 1150.

All longitudinal and transverse joints should meet the requirements of OPSS.MUNI 310. All longitudinal joints should be staggered between the asphalt lifts. The staggering of the longitudinal joints should be accomplished by offsetting the paving edge in the upper asphalt course by a minimum of 150 mm.

Smooth transitions are required in all areas where the new pavement meets the existing asphalt surface. Frost tapers of 10H:1V should be incorporated at the transition areas with the existing pavement.

If the pavement construction occurs in wet, winter or inclement weather, it may be necessary to provide additional subgrade support for heavy construction traffic by increasing the thickness of the granular subbase, base or both. Further, traffic areas for construction equipment may experience unstable subgrade conditions. These areas may be stabilized utilizing additional thickness of granular materials or geogrid.



It should be noted that in addition to adherence of the above pavement design recommendations, a close control on the pavement construction process will also be required in order to obtain the desired pavement life. Therefore, it is recommended that regular inspection and testing should be conducted during the pavement construction to confirm material quality, thickness, and to ensure adequate compaction.

4.7 Stormwater Management Pond

A SWM pond is currently proposed at the northeast corner of the site. Borehole 2 was drilled in the area. Details of the pond were not known at the time of this report.

Borehole 2 revealed topsoil over clayey silt / sandy silt layer to 2.3 m depth (Elev. 205.9). Below the clayey silt / sandy silt, red weathered shale bedrock was encountered which extended to 4.6 m depth (Elev. 203.6). The stabilized groundwater was encountered at 1.2 m depth (Elev. 207.0).

4.7.1 General Construction Considerations

Excavation and temporary groundwater control construction considerations are provided with Section 5.1 of this report and apply to the construction of the SWM pond.

The steepest recommended pond slope inclination is 5H:1V and should follow the design guidelines of the local municipality.

It is recommended that any piping or trenching in the area of the pond should be provided with seepage cut-off collars (clay plugs, concrete plugs, or other barriers) to protect against water seepage through the pipe bedding and backfill.

Pond berms above grade will have to be constructed as engineered fill, constructed as described earlier in the report.

4.7.2 Pond Slope Surface Treatment

The final slope surface and all bare or exposed areas (where applicable) should be provided with suitable vegetation cover or erosion protection. The sloped surface should be provided with a layer of topsoil (minimum 100 mm thick) and should be hydro-seeded, with a grass mixture and mulch. If seeded, during the first 2 to 3 years, the surface cover of topsoil and seeding may require periodic maintenance until the vegetation becomes well established. It is recommended that erosion netting/erosion control blankets be staked on the slope surface for erosion protection (including the inside slope above the water level).



4.7.3 Liner Considerations

Depending on the type of SWM pond that is planned, a liner may be required if a permanent pool is proposed. The liner should be placed along the entire pond bottom and extend a minimum of 1.0 m above the permanent pool elevation. The liner may consist of a natural soil material (such as clay), a synthetic membrane liner (such as a High-Density Polyethylene, Geosynthetic Clay Liner, or PVC), a concrete liner, or a combination thereof. Details can be provided when the design has progressed.

The liner system must be designed to withstand uplift pressure due to hydrostatic head at the base of the liner for the worse-case condition when the pond is emptied for cleaning and maintenance activities. Uplift pressure can be assessed and reviewed when design details are established. A gravel/rip rap protection layer should also be considered for the liner when the pond is cleaned out in the future.



5. Constructability Considerations

5.1 Excavations

At this time, excavations for the project site are anticipated to be about 3.0 m below existing grade to account for site servicing, SWM pond and buildings. Below the surficial materials, excavations are anticipated to encounter clayey silt/silty clay/sandy silt/silt over a weathered shale bedrock. Harder digging can be expected in the shale bedrock.

Excavations must be carried out in accordance with the Occupational Health and Safety Act, Ontario Regulation 213/91 (as amended), Construction Projects, Part III - Excavations, Section 222 through 242. Where workers must enter a trench or excavation the soil must be suitably sloped and/or braced in accordance with the OHSA. These regulations designate four (4) broad classifications of soils to stipulate appropriate measures for excavation safety. If more than one soil type is encountered in an excavation, the most conservative soil type must be followed for sloping the sidewalls of the excavation. It is expected that most excavations should be completed considering a Type 3 soil geometry, 1H:1V from the base of the excavation, assuming that the soils are dewatered/groundwater is controlled prior to excavation.

Excavation sidewalls will need to be continuously reviewed for evidence of instability and groundwater seepage, particularly following periods of heavy rain or thawing. When required, remedial action must be taken to ensure the continued stability of excavation slopes and the safety of the workers.

Minimum support system requirements for steeper excavations are stipulated in Sections 235 through 238 and 241 of the OHSA and include provisions for timbering, shoring and moveable trench boxes. To reduce the potential for instability of the trench excavations, materials excavated from the service trenches and/or other fill materials or heavy equipment should not be placed near the crest of the trench excavations.

It is important to note that soils encountered in the construction excavations may vary significantly across the site. Our preliminary soil classifications are based solely on the materials encountered in the boreholes advanced on site. The contractor should verify that similar conditions exist throughout the proposed area of excavation. If different subsurface conditions are encountered at the time of construction, we recommend that GEI be contacted immediately to evaluate the conditions encountered.



5.2 Temporary Construction Groundwater Control

As noted above excavation is envisioned to extend to about 3.0 m depth for the project.

The stabilized groundwater levels in the monitoring wells in December 2023 were 0.2 to 3.6 m below the existing ground surface and ranged between Elev. 209.1 to 211.1.

Excavation into the sandy silt /silt below the ground water table will yield moderate seepage volumes. Where excavation extends into the clayey silt, silty clay and weathered shale bedrock, lower seepage volumes should be expected.

The exact scenario where certain groundwater control techniques will work are directly correlated to how coarse/fine the native soils are in an excavation, and both the lateral and vertical extent of the wet cohesionless deposits encountered as noted above. If the groundwater table is not controlled during construction, the base of the excavations will be unstable, leading to difficulties in excavating and placement of pipes, footings or engineered fill, and providing safety for the workers.

Conventional sump pumping should suffice to control groundwater seepage for excavations about 1.0 to 2.0 m below the encountered groundwater level.

Excavation much more than 1.0 to 2.0 m below the ground water level or into entirely cohesionless soils might require pumping from several sumps or keg wells in order to control the groundwater table.

It is recommended to carry out the work during the dry time of the year when the groundwater table is lowest, to mitigate groundwater control measures. Also reducing the size of the excavation that is open at any one time will aid in reducing groundwater control requirements.

Based on the above, a Permit-to-Take-Water (PTTW) is likely not required, however registry on the Environmental Activity and Sector Registry (EASR) system may be required for multiple excavations and may be a prudent action to allow for areas of greater groundwater seepage with no work stoppage.

When details area established, a hydrogeological site assessment may be in order to assess groundwater control volumes.

5.2.1 Compaction Specifications

SPmdd the specification to indicate the degree to which soil or aggregate is compacted. To achieve the specified SPmdd as indicated in this report, all soils or aggregates must be placed in lift thicknesses no greater than 200 mm. If this is not the case, only the upper portion of the lift will be adequately compacted, and the lower portion of the lift has a high probability of not meeting compaction specifications. In addition, industry standard equipment used to determine



the degree of compaction consists of nuclear densometers. These devices have an inherent limitation in that they cannot test beyond 300 mm in depth, and so the degree of compaction beyond this depth cannot be quantitatively determined.

Along with lift thickness, ensuring that the soil or aggregate is within 2% of its optimum moisture content ensures that the specified compaction can be reached. If the soil or aggregate is too dry/wet, it is either very difficult or impossible to reach the specified compaction. This is especially true for when higher compaction specifications such as 98% and 100% SPmdd are required. Based on our review of the soil types encountered in the boreholes with associated moisture contents, the soils at this site above the groundwater table are near optimum and the soil below the groundwater table is wet of optimum.

Moisture can be increased by adding water and mixing the soil prior to re-use, blending the soil with wetter material, or by importing soil to the site that is at optimum and can be readily compacted.

Moisture can be reduced by tilling or spreading out the soil to dry or blending it with drier material. In-situ moisture contents can change based on the season and local groundwater levels and can also change for stockpiled material due to precipitation. Zones of the fine-grained soil beneath the site have very high moisture contents and moisture conditioning may be difficult to accomplish.

In addition to the above compaction specifications, in any areas where compacted fill will be placed over the exposed native soil subgrade, any loose, soft, wet, organic or unstable areas should be sub-excavated, and backfilled with clean earth fill or Granular 'B' (OPSS.MUNI 1010) compacted to a minimum of 95% SPmdd. This recommendation applies to site servicing and pavement subgrades. Where structures/buildings require upfilling beneath the structure the fill should be compacted to 100% SPmdd.

5.3 Quality Verification Services

On-site quality verification services are an integral part of the geotechnical design function, and for foundations and engineered fill, are required under the Ontario Building Code. Quality verification services are used to confirm that construction is being conducted in general conformance with the requirements as outlined in the drawings, reports and specifications prepared for the proposed development.

GEI Consultants can provide all the on-site quality verification services outlined below:

- The subgrade for shallow foundations must be field reviewed by the geotechnical engineer per the OBC.



- Installation of retaining structures over 1.0 m high and related backfilling operations must be field reviewed on a continuous basis by the geotechnical engineer as required in the OBC.
- Full-time monitoring, testing and inspection of engineered fill placement is required by the geotechnical engineer per the OBC.
- Part-time monitoring of the subgrade support capabilities, material quality, lift thickness, moisture content, degree of compaction, etc. is recommended for the following areas to ensure the recommendations within this report are followed and they perform adequately in the long-term;
 - Slab-on-grades;
 - Pavement structure (granular and asphalt); and
 - Bedding/backfilling of site servicing.
- Testing of the concrete (compressive strength, slump, air content, etc.) and testing of the asphalt (asphalt content and gradation) are recommended to ensure that the quality of the materials being brought to site meet the requirements of the project.

5.4 Site Work

The soils found at this site may become weakened when subjected to traffic, particularly when wet. If there is site work carried out during periods of wet weather, then it can be expected that the subgrade will be disturbed unless an adequate granular working surface is provided to protect the integrity of the subgrade soils from construction traffic. Subgrade preparation works cannot be adequately accomplished during wet weather and the project must be scheduled accordingly. The disturbance caused by the traffic can result in the removal of disturbed soil and use of granular fill material for site restoration or underfloor fill that is not intrinsic to the project requirements.

The most severe loading conditions on the subgrade may occur during construction. Consequently, special provisions such as end dumping and forward spreading of earth and aggregate fills, restricted construction lanes, and half-loads during paving and other work may be required, especially if construction is carried out during unfavourable weather.

If construction proceeds during freezing weather conditions, adequate temporary frost protection for the founding subgrade and concrete must be provided. The soil at this site is susceptible to frost damage. Consideration must be given to frost effects, such as heave or softening, on exposed soil surfaces in the context of this particular project development.



6. Limitations and Conclusions

6.1 Limitations

The recommendations and comments provided are necessarily on-going as new information of underground conditions becomes available. More specific information with respect to the conditions between samples, or the lateral and vertical extent of materials may become apparent during excavation operations. The interpretation of the borehole information must, therefore, be validated during excavation operations. Consequently, conditions not observed during this investigation may become apparent. Should this occur, GEI should be contacted to assess the situation and additional testing and reporting may be required.

GEI should be retained for a general review of the final design drawings and specifications to verify that this report has been properly interpreted and implemented. If not accorded the privilege of making this review, GEI will assume no responsibility for interpretation of the recommendations in the report.

The comments given in this report are intended only for the guidance of the design engineers. The number of boreholes required to determine the localized underground conditions between boreholes affecting construction costs, techniques, sequencing, equipment, scheduling, etc. could be greater than has been carried out for design purposes. Contractors bidding on or undertaking the works should, in this light, decide on their own investigations, as well as their own interpretations of the factual borehole results, so that they may draw their own conclusions as to how the subsurface conditions may affect them.

This report was authorized by, and prepared by GEI for, the account of Graham Construction & Design (as provided the signed Standard Professional Services Agreement). Any use which a third party makes of this report, or any reliance on or decisions to be made based on it, are the responsibility of such third parties. GEI accepts no responsibility for damages, if any, suffered by any third party as a result of decisions made or actions based on this project.



6.2 Conclusion

It is recognized that municipal/regional governing bodies, in their capacity as the planning and building authority under Provincial statutes, will make use of and rely upon this report, cognizant of the limitations thereof, both as are expressed and implied.

We trust this report is complete within our terms of reference, and the information presented is sufficient for your present purposes. If you have any questions, or when we may be of further assistance, please do not hesitate to contact our office.

Yours Truly,

GEI Consultants

Prepared By:

Reviewed By:



Mohammed Razeen
Geotechnical E.I.T.

Geoffrey R. White, P.Eng.
Barrie Office Branch Manager and
Senior Geotechnical Engineer

Figures

Site Location Plan

Borehole Location Plans



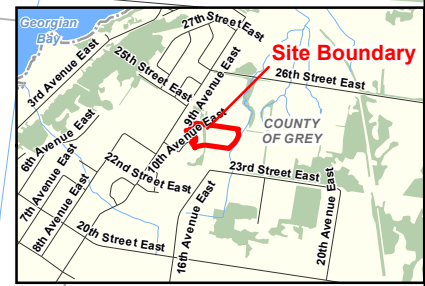
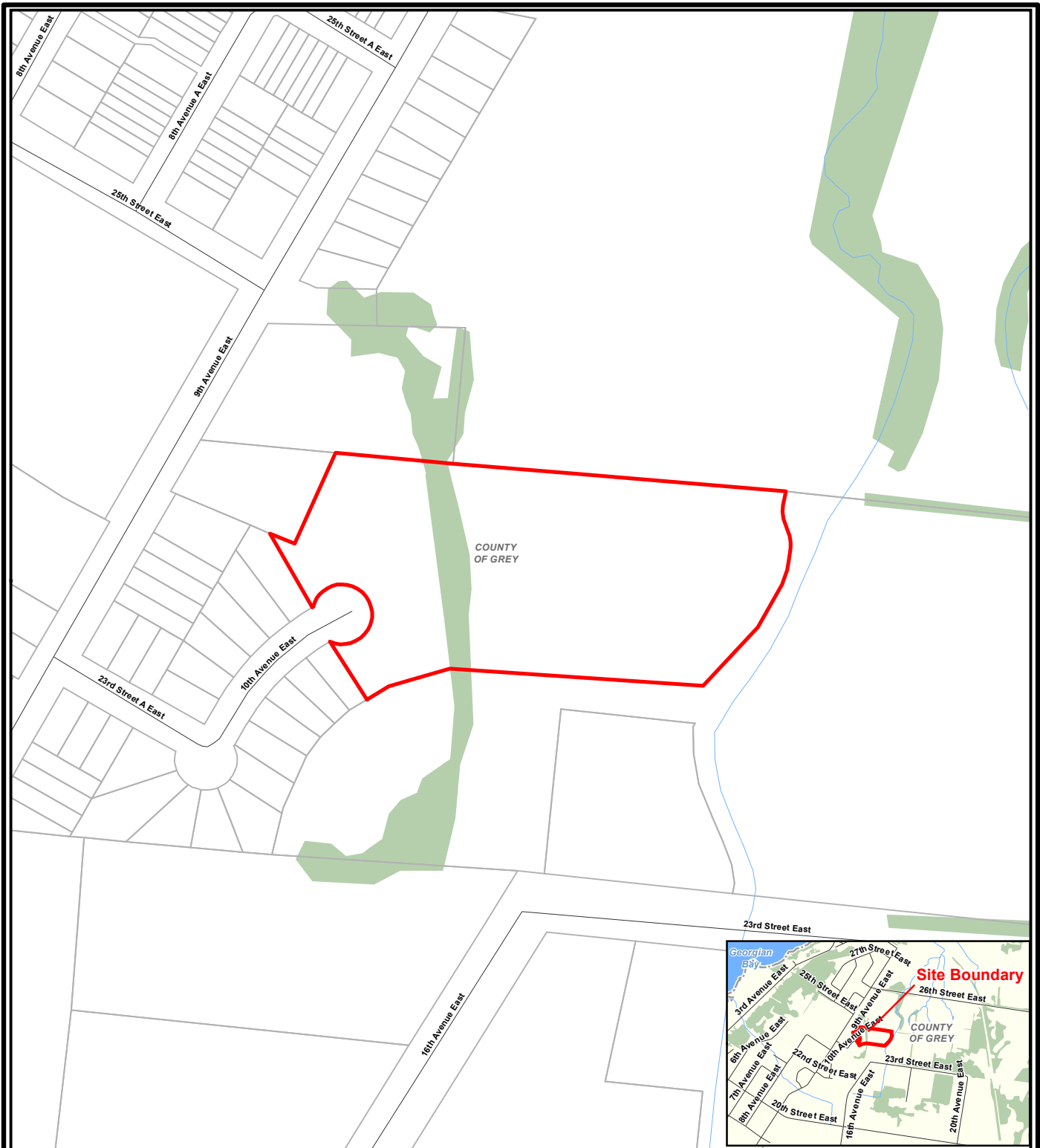

NOTES:

1. Coordinate System: NAD 1983 UTM Zone 17N.
2. Base features produced under license with the Ontario Ministry of Natural Resources and Forestry © Queen's Printer for Ontario, 2024.

Legend

- Site Boundary
- Watercourse
- Highway
- Waterbody
- Road
- Wooded Area

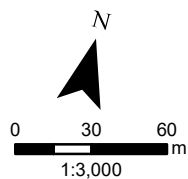

10th Avenue Owen Sound,
Ontario

Graham Construction & Design



Project 2305091

SITE LOCATION PLAN

Feb 2024

Fig. 1



NOTES:

1. Coordinate System: NAD 1983 UTM Zone 17N.
2. Base features produced under license with the Ontario Ministry of Natural Resources and Forestry © Queen's Printer for Ontario, 2024.
3. Orthoimagery © First Base Solutions, 2024. Imagery taken in 2020.

Legend

- ▭ Site Boundary
- Borehole
- Road
- Borehole/ Monitoring Wells
- Watercourse

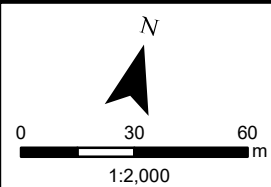

10th Avenue Owen Sound,
Ontario

Graham Construction & Design



Project 2305091

BOREHOLE LOCATION PLAN
(AERIAL)

Feb 2024

Fig. 2A

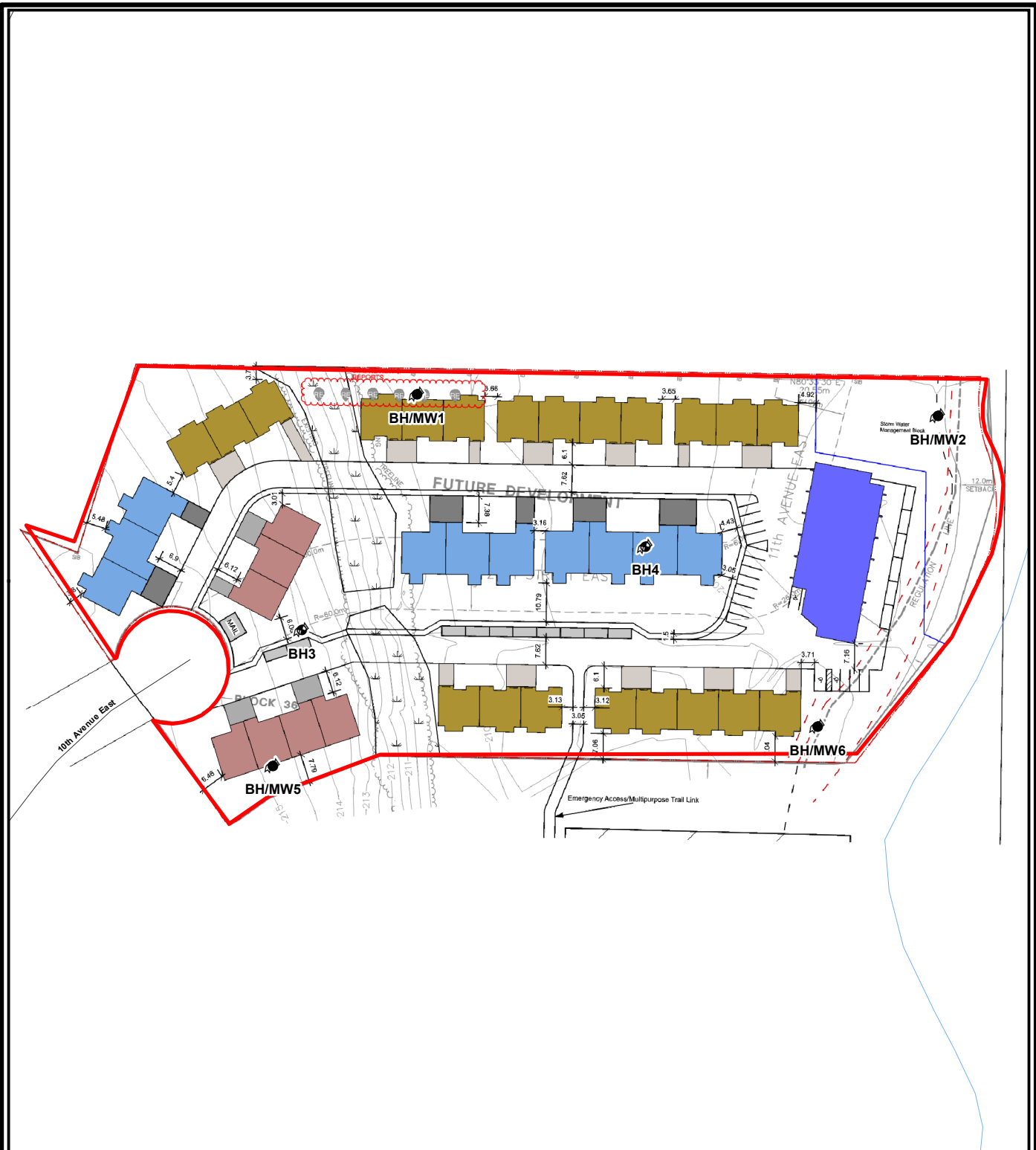

NOTES:

1. Coordinate System: NAD 1983 UTM Zone 17N.
2. Base features produced under license with the Ontario Ministry of Natural Resources and Forestry © Queen's Printer for Ontario, 2024.

Legend

- ▭ Site Boundary
- Road
- Watercourse
- Borehole
- Borehole/ Monitoring Wells

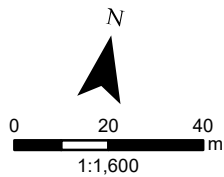

10th Avenue Owen Sound,
Ontario

Graham Construction & Design



Project 2305091

BOREHOLE SITE PLAN

Feb 2024

Fig. 2B

Appendix A

Borehole Logs



RECORD OF BOREHOLE No. 1



Project Number: **2305091**
 Project Client: **Graham Construction & Design**
 Project Name: **10th Ave Estates Residential Development**
 Project Location: **10th Ave and 23rd St E, Owen Sound, ON**
 Drilling Location: **See Borehole Location Plan**
 Local Benchmark: _____

Drilling Method: **Hollow Stem Augers** Drilling Machine: **Track Mount**
 Logged By: **CS** Northing: **4937208** Date Started: **Nov 20/23**
 Reviewed By: **GW** Easting: **506465.8** Date Completed: **Nov 20/23**

LITHOLOGY PROFILE	SOIL SAMPLING				DEPTH (m)	ELEVATION (m)	FIELD TESTING		LAB TESTING		Instrumentation Installation	COMMENTS & GRAIN SIZE DISTRIBUTION (%)						
	DESCRIPTION	Sample Type	Sample Number	Recovery (%)			SPT "N" Value	Shear Strength Testing (kPa)	Penetration Testing	Atterberg Limits		Water Content (%)	GR	SA	SI	CL		
0.0 - 209.9	TOPSOIL: 200 mm	SS	1	75	3	209.7												
0.2 - 209.1	CLAYEY SILT: Trace sand, soft, light brown, very moist	SS	2	75	30	209.1												
0.8 - 207.6	CLAYEY SILT / SANDY SILT: Layered clayey silt and sandy silt, compact/very stiff, brown to grey, moist	SS	3	75	15	207.6												
2.3 - 206.8	SILT: Some fine sand, trace clay, loose, grey, wet	SS	4	75	6	206.8												
3.0 - 205.2	SILTY CLAY: Very soft, grey, wet	SS	5	75	2	205.2												
4.6 - 205.2	WEATHERED SHALE BEDROCK: Red, dry Borehole Terminated at 4.7 m	SS	6	25	50+	205.2												

GEI CONSULTANTS
 647 Welham Road, Unit 14
 Barrie, Ontario L4N 0B7
 T : (705) 719-7994
 www.geiconsultants.com

Groundwater depth encountered on completion of drilling: Dry C Cave depth after auger removal: Open
 Groundwater depth observed on: Dec 4/23 at depth of: 0.2 m. Groundwater Elevation: 209.7 m

Borehole details presented do not constitute a thorough understanding of all potential conditions present and require interpretative assistance from a qualified geotechnical engineer. Also, borehole information should be read in conjunction with the geotechnical report for which it was commissioned and the accompanying 'Explanation of Boring Log'.

Scale: 1 : 75
 Page: 1 of 1

RECORD OF BOREHOLE No. 2



Project Number: 2305091
 Project Client: Graham Construction & Design
 Project Name: 10th Ave Estates Residential Development
 Project Location: 10th Ave and 23rd St E, Owen Sound, ON
 Drilling Location: See Borehole Location Plan
 Local Benchmark: _____

Drilling Method: Hollow Stem Augers Drilling Machine: Track Mount
 Logged By: CS Northing: 4937235 Date Started: Nov 20/23
 Reviewed By: GW Easting: 506634.8 Date Completed: Nov 20/23

LITHOLOGY PROFILE	SOIL SAMPLING				DEPTH (m)	ELEVATION (m)	FIELD TESTING		LAB TESTING		Instrumentation Installation	COMMENTS & GRAIN SIZE DISTRIBUTION (%)						
	DESCRIPTION	Sample Type	Sample Number	Recovery (%)			SPT "N" Value	Shear Strength Testing (kPa)	Penetration Testing	Atterberg Limits		Water Content (%)	GR	SA	SI	CL		
0.0 - 208.2	TOPSOIL: 200 mm	SS	1	75	4	0	4											
0.2 - 208.0	CLAYEY SILT: Some sand, soft, slightly mottled brown, very moist	SS	2	75	4	0.2	4			27								
0.8 - 207.4	CLAYEY SILT / SANDY SILT: Layered clayey silt and sandy silt, loose/firm, brown to grey, very moist	SS	3	75	6	1.5	6			28								
2.3 - 205.9	WEATHERED SHALE BEDROCK: Red, dry	SS	4	25	50	2.3	6			32								
		SS	5	25	50+	3.0	50			11								
		SS	6	25	50+	4.6	50+			9								
	Borehole Terminated at 4.6 m	SS	6	25	50+	4.6	50+											

GEI CONSULTANTS
 647 Welham Road, Unit 14
 Barrie, Ontario L4N 0B7
 T : (705) 719-7994
 www.geiconsultants.com

Groundwater depth encountered on completion of drilling: Dry C Cave depth after auger removal: Open
 Groundwater depth observed on: Dec 4/23 at depth of: 1.2 m. Groundwater Elevation: 207.0 m

Borehole details presented do not constitute a thorough understanding of all potential conditions present and require interpretative assistance from a qualified geotechnical engineer. Also, borehole information should be read in conjunction with the geotechnical report for which it was commissioned and the accompanying 'Explanation of Boring Log'.

RECORD OF BOREHOLE No. 3



Project Number: 2305091
 Project Client: Graham Construction & Design
 Project Name: 10th Ave Estates Residential Development
 Project Location: 10th Ave and 23rd St E, Owen Sound, ON
 Drilling Location: See Borehole Location Plan
 Local Benchmark: _____

Drilling Method: Hollow Stem Augers Drilling Machine: Track Mount
 Logged By: CS Northing: 4937136 Date Started: Nov 20/23
 Reviewed By: GW Easting: 506446.4 Date Completed: Nov 20/23

LITHOLOGY PROFILE	SOIL SAMPLING				DEPTH (m)	ELEVATION (m)	FIELD TESTING		LAB TESTING				Instrumentation Installation	COMMENTS & GRAIN SIZE DISTRIBUTION (%)				
	DESCRIPTION	Sample Type	Sample Number	Recovery (%)			SPT "N" Value	Shear Strength Testing (kPa)		Atterberg Limits				GR	SA	SI	CL	
0.0 - 213.8 TOPSOIL: 100 mm	SS	1	75	13	0	213.8	○ 13	○ 16										
0.0 - 213.8 SANDY SILT: Trace to some gravel, trace clay, compact to very dense, brown, moist	SS	2	75	22	0	213	○ 22	○ 7										
2.3 - 211.6 GRAVELLY SILTY SAND: Trace clay, dense, brown, wet	SS	3	75	57	1.5	211.6	○ 57	○ 6										
2.3 - 211.6 GRAVELLY SILTY SAND: Trace clay, dense, brown, wet	SS	4	75	31	2.3	211.6	○ 31	○ 8						24	42	28	6	
3.0 - 210.8 WEATHERED SHALE BEDROCK: Red, dry	SS	5	25	50+	3.0	210.8	○ 50+	○ 8										
4.7 - 209.2 Borehole Terminated at 4.7 m	SS	6	25	50+	4.7	209.2	○ 50+	○ 5										

GEI CONSULTANTS
 647 Welham Road, Unit 14
 Barrie, Ontario L4N 0B7
 T : (705) 719-7994
 www.geiconsultants.com

Groundwater depth encountered on completion of drilling: Dry ○ Cave depth after auger removal: 2.5 m.
 Groundwater depth observed on: _____ Groundwater Elevation: _____

Borehole details presented do not constitute a thorough understanding of all potential conditions present and require interpretative assistance from a qualified geotechnical engineer. Also, borehole information should be read in conjunction with the geotechnical report for which it was commissioned and the accompanying 'Explanation of Boring Log'.

RECORD OF BOREHOLE No. 4



Project Number: 2305091
 Project Client: Graham Construction & Design
 Project Name: 10th Ave Estates Residential Development
 Project Location: 10th Ave and 23rd St E, Owen Sound, ON
 Drilling Location: See Borehole Location Plan
 Local Benchmark: _____

Drilling Method: Hollow Stem Augers Drilling Machine: Track Mount
 Logged By: CS Northing: 4937178 Date Started: Nov 20/23
 Reviewed By: GW Easting: 506537.9 Date Completed: Nov 20/23

LITHOLOGY PROFILE	SOIL SAMPLING				DEPTH (m)	ELEVATION (m)	FIELD TESTING		LAB TESTING		Instrumentation Installation	COMMENTS & GRAIN SIZE DISTRIBUTION (%)						
	DESCRIPTION	Sample Type	Sample Number	Recovery (%)			SPT "N" Value	Shear Strength Testing (kPa)	Penetration Testing	Atterberg Limits		Water Content (%)	GR	SA	SI	CL		
0.0 - 208.4 TOPSOIL: 75 mm	SS	1	75	9		208.4	○ 9											
CLAYEY SILT: Stiff, mottled brown, moist																		
1.1 - 208.3 SANDY SILT: Compact, light brown, wet	SS	2	75	20		208.3	○ 20			16								
1.5 - 207.9 SILT: Some clay, trace sand, loose, brown, wet	SS	3	75	9		207.9	○ 9			23				0	1	87	12	
2.3 - 207.1 SILTY CLAY: Very soft to soft, grey, wet	SS	4	75	0		207.1	○ 0			26								
	SS	5	75	4		207.1	○ 4			13								
4.0 - 205.4 WEATHERED SHALE BEDROCK: Red, dry						205.4												
4.3 - 205.1 Borehole Terminated at 4.3 m Upon Auger Refusal						205.1												

GEI CONSULTANTS
 647 Welham Road, Unit 14
 Barrie, Ontario L4N 0B7
 T : (705) 719-7994
 www.geiconsultants.com

Groundwater depth encountered on completion of drilling: Dry C Cave depth after auger removal: 2.3 m.
 Groundwater depth observed on: _____ Groundwater Elevation: _____

Borehole details presented do not constitute a thorough understanding of all potential conditions present and require interpretative assistance from a qualified geotechnical engineer. Also, borehole information should be read in conjunction with the geotechnical report for which it was commissioned and the accompanying 'Explanation of Boring Log'.

Scale: 1 : 75
 Page: 1 of 1

RECORD OF BOREHOLE No. 5



Project Number: **2305091**
 Project Client: **Graham Construction & Design**
 Project Name: **10th Ave Estates Residential Development**
 Project Location: **10th Ave and 23rd St E, Owen Sound, ON**
 Drilling Location: **See Borehole Location Plan**
 Local Benchmark: _____

Drilling Method: **Hollow Stem Augers** Drilling Machine: **Track Mount**
 Logged By: **CS** Northing: **4937095** Date Started: **Nov 20/23**
 Reviewed By: **GW** Easting: **506752.8** Date Completed: **Nov 20/23**

LITHOLOGY PROFILE	SOIL SAMPLING				DEPTH (m)	ELEVATION (m)	FIELD TESTING	LAB TESTING	Instrumentation Installation	COMMENTS & GRAIN SIZE DISTRIBUTION (%)									
	DESCRIPTION	Sample Type	Sample Number	Recovery (%)						SPT "N" Value	GR	SA	SI	CL					
0.0 - 214.7	TOPSOIL: 100 mm	SS	1	75	17														
0.1 - 213.9	FILL: Silty sand and gravel, compact, brown, moist	SS	2	75	34														
0.8 - 213	SANDY SILT: Trace to some gravel, trace clay, sandy layers, dense to compact, brown, moist to wet	SS	3	75	37														
		SS	4	75	25														
		SS	5	75	13														
4.6 - 210.1	SILTY CLAY: Very stiff, grey to brown, wet	SS	6	75	26														
6.1 - 208.6	WEATHERED SHALE BEDROCK: Red, dry																		
7.7 - 207.1	Inferred bedrock on difficult augering Borehole Terminated at 7.7 m	AS	7	25	100+														

GEI CONSULTANTS
 647 Welham Road, Unit 14
 Barrie, Ontario L4N 0B7
 T : (705) 719-7994
 www.geiconsultants.com

Groundwater depth encountered on completion of drilling: Dry Cave depth after auger removal: Open
 Groundwater depth observed on: Dec 4/23 at depth of: 3.6 m. Groundwater Elevation: 211.1 m

Borehole details presented do not constitute a thorough understanding of all potential conditions present and require interpretative assistance from a qualified geotechnical engineer. Also, borehole information should be read in conjunction with the geotechnical report for which it was commissioned and the accompanying 'Explanation of Boring Log'.

RECORD OF BOREHOLE No. 6



Project Number: 2305091
 Project Client: Graham Construction & Design
 Project Name: 10th Ave Estates Residential Development
 Project Location: 10th Ave and 23rd St E, Owen Sound, ON
 Drilling Location: See Borehole Location Plan
 Local Benchmark: _____

Drilling Method: Hollow Stem Augers Drilling Machine: Track Mount
 Logged By: CS Northing: 4937137 Date Started: Nov 20/23
 Reviewed By: GW Easting: 506595.8 Date Completed: Nov 20/23

LITHOLOGY PROFILE	SOIL SAMPLING				DEPTH (m)	ELEVATION (m)	FIELD TESTING		LAB TESTING		Instrumentation Installation	COMMENTS & GRAIN SIZE DISTRIBUTION (%)						
	DESCRIPTION	Sample Type	Sample Number	Recovery (%)			SPT "N" Value	Shear Strength Testing (kPa)	Penetration Testing	Atterberg Limits		Water Content (%)	GR	SA	SI	CL		
0.0 - 209.3 TOPSOIL: 100 mm	SS	1	75	5		209.3												
0.8 - 208.5 CLAYEY SILT: Sand and gravel, firm, brown, very moist	SS	2	75	7		208.5												
2.3 - 207.0 CLAYEY SILT / SANDY SILT: Layered clayey silt and sandy silt, loose/firm to stiff, brown to grey, very moist	SS	3	75	10		207.0												
3.1 - 206.2 SILTY CLAY: Very soft, light brown to grey, wet	SS	4	75	1		206.2												
3.5 - 205.8 WEATHERED SHALE BEDROCK: Red, dry	SS	5	25	50+		205.8												
Borehole Terminated at 3.5 m																		

GEI CONSULTANTS
 647 Welham Road, Unit 14
 Barrie, Ontario L4N 0B7
 T : (705) 719-7994
 www.geiconsultants.com

Groundwater depth encountered on completion of drilling: Dry C Cave depth after auger removal: 2.7 m.
 Groundwater depth observed on: Dec 4/23 at depth of: 0.2 m. Groundwater Elevation: 209.1 m

Borehole details presented do not constitute a thorough understanding of all potential conditions present and require interpretative assistance from a qualified geotechnical engineer. Also, borehole information should be read in conjunction with the geotechnical report for which it was commissioned and the accompanying 'Explanation of Boring Log'.

Scale: 1 :75
 Page: 1 of 1

Appendix B

Geotechnical Laboratory Testing



UNIFIED SOIL CLASSIFICATION SYSTEM

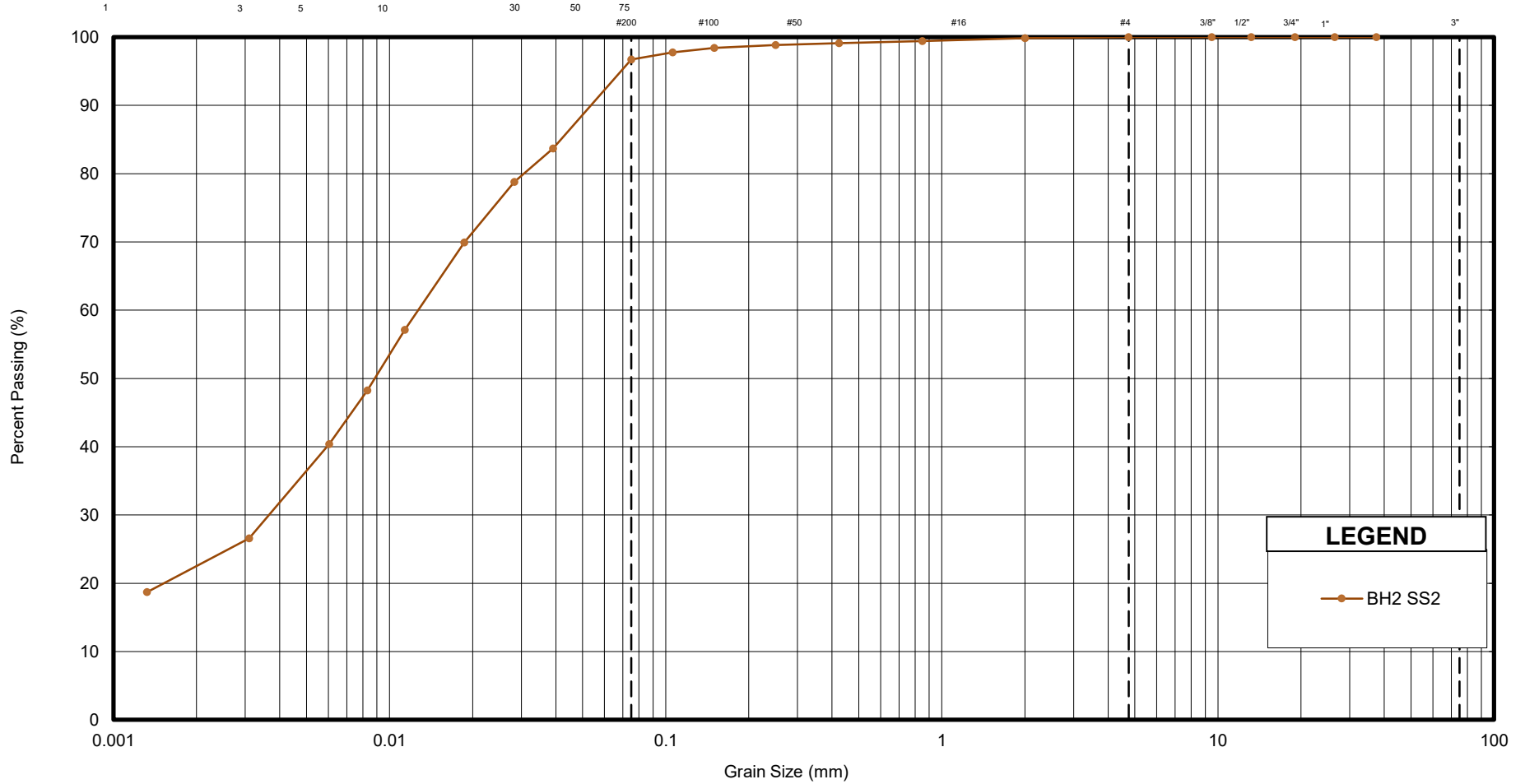
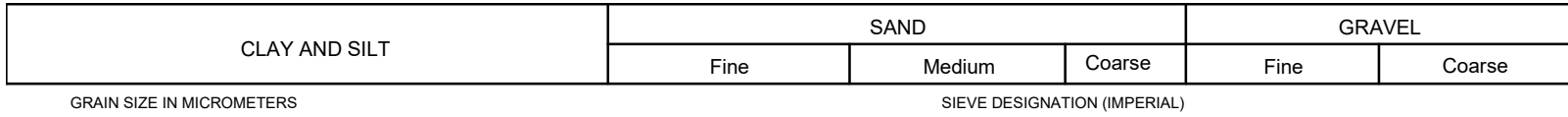

LEGEND

—●— BH2 SS2

Sample	Description	Gr.	Sa.	Si.	Cl.	D ₁₀	D ₃₀	D ₆₀	C _u	C _c
BH2 SS2	CLAYEY SILT, Trace Sand	-	3	74	23	-	0.004	0.013	-	-

	GRAIN SIZE DISTRIBUTION - 10th Ave Estates Residential Development	FIGURE No. B1
	CLAYEY SILT	REF. No. 2305091
		DATE Feb 2024

UNIFIED SOIL CLASSIFICATION SYSTEM

CLAY AND SILT	SAND			GRAVEL	
	Fine	Medium	Coarse	Fine	Coarse

GRAIN SIZE IN MICROMETERS

SIEVE DESIGNATION (IMPERIAL)

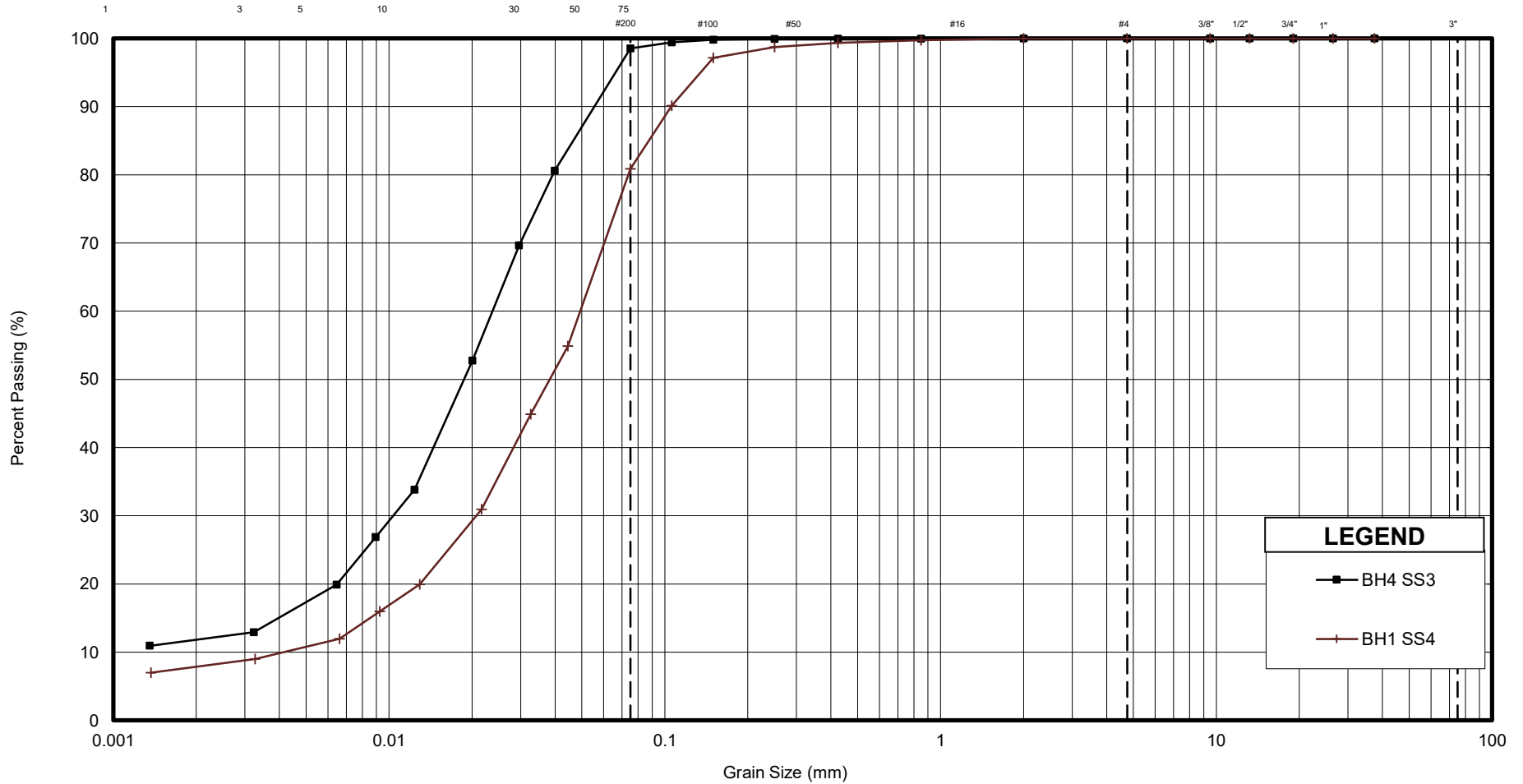

Sample	Description	Gr.	Sa.	Si.	Cl.	D ₁₀	D ₃₀	D ₆₀	C _u	C _c
BH4 SS3	SILT, Some Clay, Trace Sand	-	1	87	12	-	0.010	0.024	-	-
BH1 SS4	SILT, Some Sand, Trace Clay	-	19	73	8	0.004	0.021	0.049	11.9	2.1



GRAIN SIZE DISTRIBUTION - 10th Ave Estates Residential Development

SILT

FIGURE No. B2

REF. No. 2305091

DATE Feb 2024

UNIFIED SOIL CLASSIFICATION SYSTEM

CLAY AND SILT	SAND			GRAVEL	
	Fine	Medium	Coarse	Fine	Coarse

GRAIN SIZE IN MICROMETERS

SIEVE DESIGNATION (IMPERIAL)

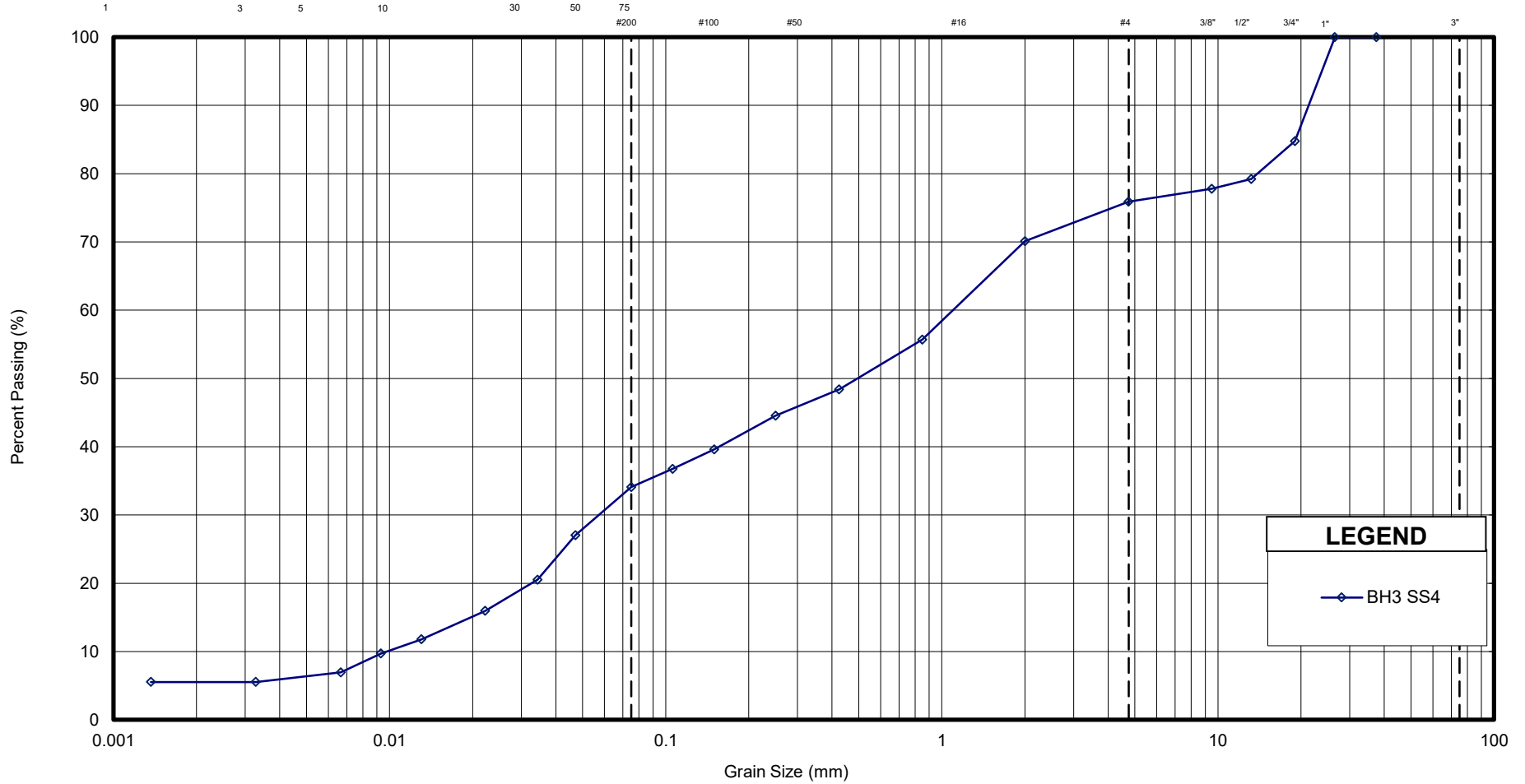

LEGEND
—◇— BH3 SS4

Sample	Description	Gr.	Sa.	Si.	Cl.	D ₁₀	D ₃₀	D ₆₀	C _u	C _c
BH3 SS4	GRAVELLY SILTY SAND, Trace Clay	24	42	28	6	0.010	0.057	1.097	112.5	0.3



GRAIN SIZE DISTRIBUTION - 10th Ave Estates Residential Development

GRAVELLY SILTY SAND

FIGURE No. B3

REF. No. 2305091

DATE Feb 2024

Appendix C

Typical Details



Notes:

1. Engineered Fill compacted to 100% Standard Proctor Maximum Dry Density (SPMDD) and inspected under the full time supervision of GEI.
2. Engineered fill must be placed in loose lifts of 200 mm or less and then compacted as noted above.
3. Interior non-structural compacted fill compacted to 98% SPMDD with recommended part-time inspection.

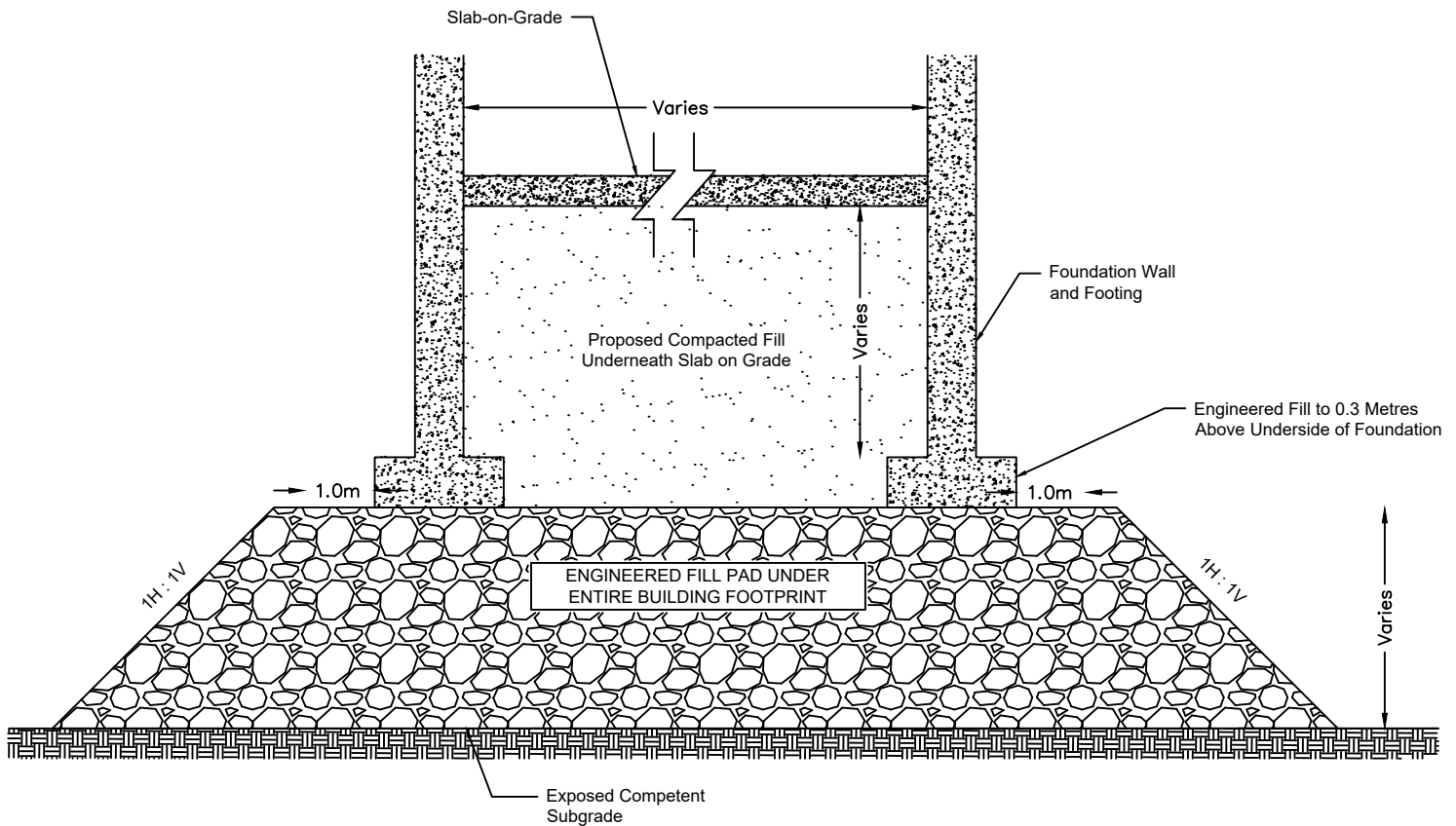

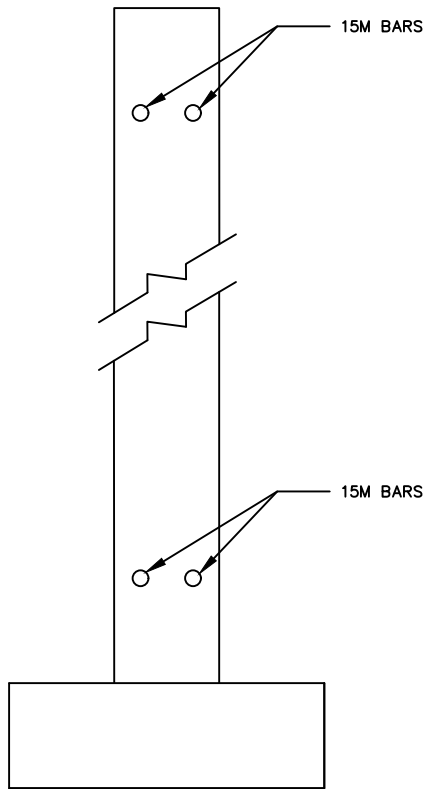

TYPICAL REINFORCED WALL

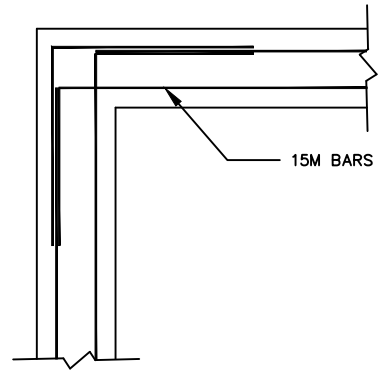

TYPICAL SPLICING AT CORNERS

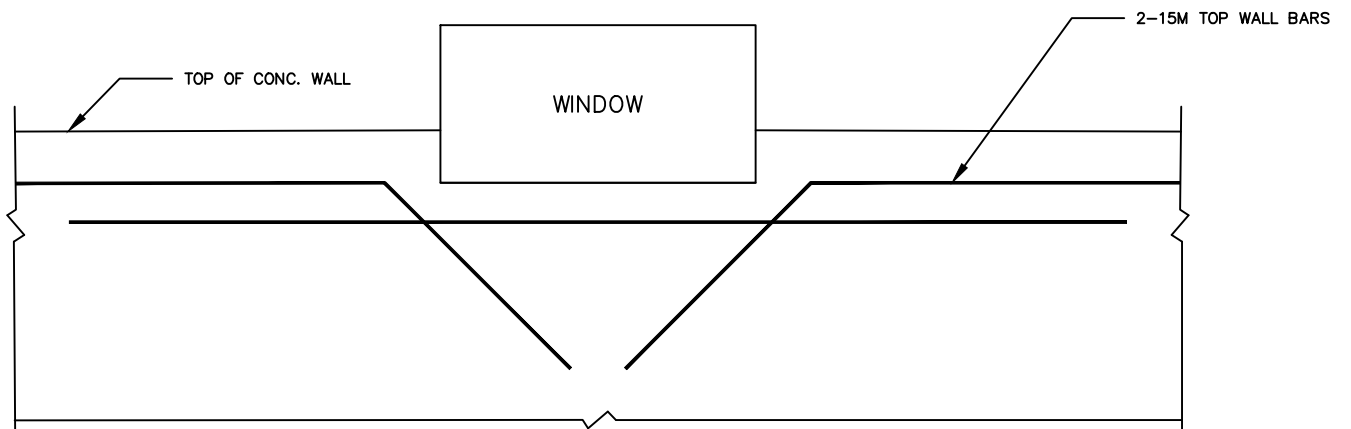

TYPICAL WINDOW REINFORCING

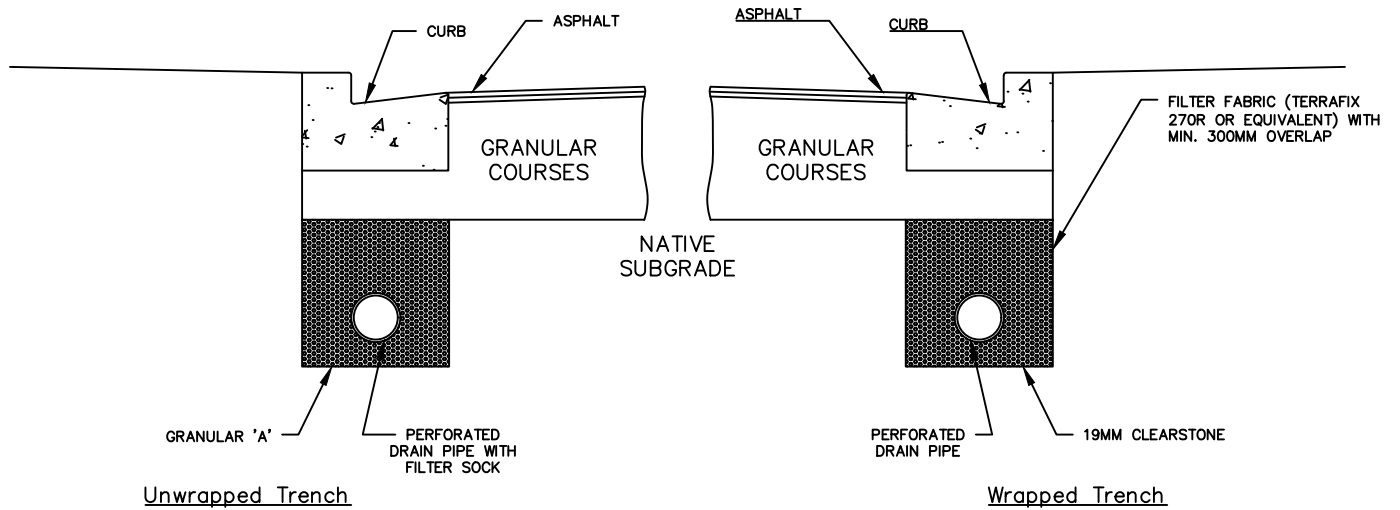
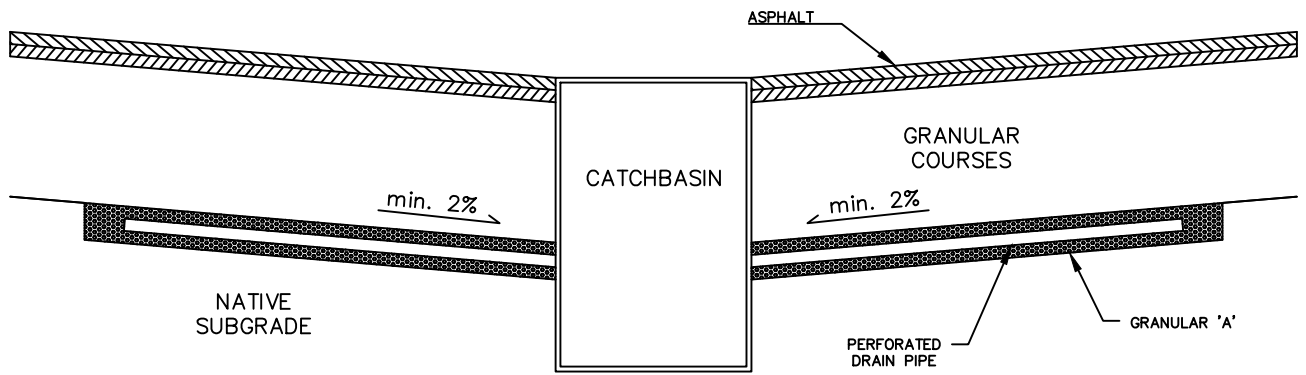

Urban Cross Sections

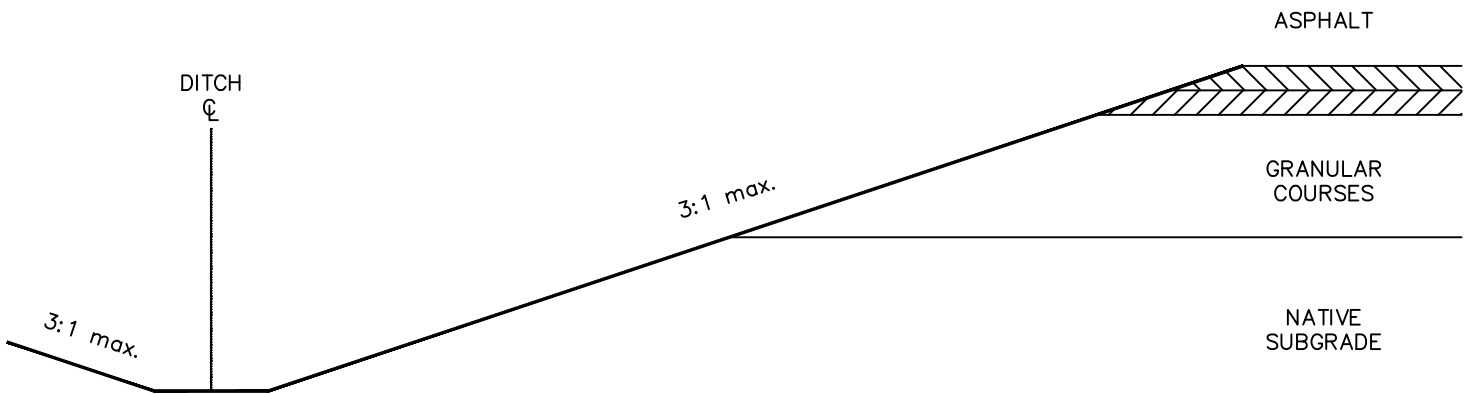

Rural Cross Section